

# INSTRUCTION MANUAL FOR



## RUGER® GP100® DOUBLE-ACTION REVOLVER



– RUGGED, RELIABLE FIREARMS® –



**READ THE INSTRUCTIONS AND  
WARNINGS IN THIS MANUAL CAREFULLY  
BEFORE USING THIS FIREARM**

© 2016 Sturm, Ruger & Co., Inc.

This manual may not be reproduced in whole or in part without the express written permission of Sturm, Ruger & Co., Inc.

**For Service on This Model Please Call:  
(336) 949-5200 (See p. 24)**

THIS INSTRUCTION MANUAL SHOULD ALWAYS ACCOMPANY THIS FIREARM AND BE TRANSFERRED WITH IT UPON CHANGE OF OWNERSHIP, OR WHEN THE FIREARM IS LOANED OR PRESENTED TO ANOTHER PERSON

**WWW.RUGER.COM**

KT & T 8-16 R27

## State-By-State Warnings

Certain states require by law that their own specified warning notices in larger-than-normal type be conspicuously included by the manufacturer, distributor or retailer with firearms sold in that state. Sturm, Ruger & Co., Inc. sells its products in compliance with applicable laws and regulations. Because our products may be sold in these states, we include the following:

### California:

#### **WARNING**

“Children are attracted to and can operate firearms that can cause severe injuries or death. Prevent child access by always keeping guns locked away and unloaded when not in use. If you keep a loaded firearm where a child obtains and improperly uses it, you may be fined or sent to prison.”

#### **ADVERTENCIA**

“A los niños los atraen las armas de fuego y las pueden hacer funcionar. Ellos pueden causarse lesiones graves y la muerte. Evite que los niños tengan acceso a las armas de fuego guardándolas siempre con llave y descargadas cuando no las esté utilizando. Si usted tiene un arma de fuego cargada en un lugar en que un niño tiene acceso a ella y la usa indebidamente, le pueden dar una multa o enviarlo a la cárcel.”

### Connecticut:

“UNLAWFUL STORAGE OF A LOADED FIREARM MAY RESULT IN IMPRISONMENT OR FINE.”

### Florida:

“IT IS UNLAWFUL, AND PUNISHABLE BY IMPRISONMENT AND FINE, FOR ANY ADULT TO STORE OR LEAVE A FIREARM IN ANY PLACE WITHIN THE REACH OR EASY ACCESS OF A MINOR UNDER 18 YEARS OF AGE OR TO KNOWINGLY SELL OR OTHERWISE TRANSFER OWNERSHIP OR POSSESSION OF A FIREARM TO A MINOR OR A PERSON OF UNSOUND MIND.”

## **Maine:**

“ENDANGERING THE WELFARE OF A CHILD IS A CRIME. IF YOU LEAVE A FIREARM AND AMMUNITION WITHIN EASY ACCESS OF A CHILD, YOU MAY BE SUBJECT TO FINE, IMPRISONMENT OR BOTH. KEEP FIREARMS AND AMMUNITION SEPARATE. KEEP FIREARMS AND AMMUNITION LOCKED UP. USE TRIGGER LOCKS.”

## **Maryland:**

“WARNING: Children can operate firearms which may cause death or serious injury. It is a crime to store or leave a loaded firearm in any location where an individual knew or should have known that an unsupervised minor would gain access to the firearm. Store your firearm responsibly!”

## **Massachusetts:**

“WARNING FROM THE MASSACHUSETTS ATTORNEY GENERAL: This handgun is not equipped with a device that fully blocks use by unauthorized users. More than 200,000 firearms like this one are stolen from their owners every year in the United States. In addition, there are more than a thousand suicides each year by younger children and teenagers who get access to firearms. Hundreds more die from accidental discharge. It is likely that many more children sustain serious wounds, or inflict such wounds accidentally on others. In order to limit the chance of such misuse, it is imperative that you keep this weapon locked in a secure place and take other steps necessary to limit the possibility of theft or accident. Failure to take reasonable preventive steps may result in innocent lives being lost, and in some circumstances may result in your liability for these deaths.”

“IT IS UNLAWFUL TO STORE OR KEEP A FIREARM, RIFLE, SHOTGUN OR MACHINE GUN IN ANY PLACE UNLESS THAT WEAPON IS EQUIPPED WITH A TAMPER-RESISTANT SAFETY DEVICE OR IS STORED OR KEPT IN A SECURELY LOCKED CONTAINER.”

**New Jersey:**

“IT IS A CRIMINAL OFFENSE TO LEAVE A LOADED FIREARM WITHIN EASY ACCESS OF A MINOR.”

**New York City:**

“THE USE OF A LOCKING DEVICE OR SAFETY LOCK IS ONLY ONE ASPECT OF RESPONSIBLE FIREARM STORAGE. FOR INCREASED SAFETY, FIREARMS SHOULD BE STORED UNLOADED AND LOCKED IN A LOCATION THAT IS BOTH SEPARATE FROM THEIR AMMUNITION AND INACCESSIBLE TO CHILDREN AND OTHER UNAUTHORIZED PERSONS.”

**North Carolina:**

“IT IS UNLAWFUL TO STORE OR LEAVE A FIREARM THAT CAN BE DISCHARGED IN A MANNER THAT A REASONABLE PERSON SHOULD KNOW IS ACCESSIBLE TO A MINOR.”

**Texas:**

“IT IS UNLAWFUL TO STORE, TRANSPORT, OR ABANDON AN UNSECURED FIREARM IN A PLACE WHERE CHILDREN ARE LIKELY TO BE AND CAN OBTAIN ACCESS TO THE FIREARM.”

**Wisconsin:**

“IF YOU LEAVE A LOADED FIREARM WITHIN THE REACH OR EASY ACCESS OF A CHILD YOU MAY BE FINED OR IMPRISONED OR BOTH IF THE CHILD IMPROPERLY DISCHARGES, POSSESSES, OR EXHIBITS THE FIREARM.”

\* \* \* \* \*

Please check with your licensed retailer or state police for additional warnings which may be required by local law or regulation. Such regulations change constantly, and local authorities are in the best position to advise you on such legal matters.

**FIREARMS SAFETY IS YOUR RESPONSIBILITY**  
**SAFETY MUST BE THE FIRST AND CONSTANT**  
**CONSIDERATION OF EVERY PERSON WHO HANDLES**  
**FIREARMS AND AMMUNITION.**

This Instruction Manual is designed to assist you in learning how to use and care for your RUGER® GP100® revolver properly. Please contact us if you have any questions.

Only when you are certain you fully understand the manual and can properly carry out its instructions should you practice loading, unloading, etc. with live ammunition. If you have any doubts about your ability to handle or use a particular type of gun safely, you should seek supervised instruction. Such personalized instruction often is available from local gun retailers, gun clubs or police departments. If none of these sources can help visit [www.nra.org](http://www.nra.org) or write to the following address:

National Rifle Association  
11250 Waples Mill Road  
Fairfax, VA 22030-7400

The person possessing a gun has a full-time job. You cannot guess; You cannot forget; You must know how to use your firearm safely. **Do not use any firearm without having a complete understanding of its particular characteristics and safe use.** Remember: There is no such thing as a foolproof gun.

# TABLE OF CONTENTS

	Page
State-By-State Warnings .....	2
Nomenclature .....	7
Locking Device Installation Instructions .....	8
General Information and Mechanical Characteristics .....	10
Ammunition .....	11
Handling .....	12
Dry-Firing .....	12
To Load and Fire .....	13
To Uncock (Decock) The Revolver .....	15
To Unload or Eject Cartridge Cases .....	16
Disassembly .....	18
Reassembly .....	19
Care and Cleaning .....	20
Storage .....	21
Care of Stainless Steel Revolvers .....	22
Rear Sight Adjustment – Match Champion .....	22
Sights .....	23
Sight Adjustments - 327 Federal Magnum .....	23
Service and Parts Policy .....	24
Shipping Firearms for Repair .....	24
Ordering Parts .....	25
Parts List .....	26
Exploded Views .....	28
Supplemental Parts List & Exploded View – Match Champion .....	30
<b>The Basic Rules of Safe Firearms Handling .....</b>	<b>31</b>
Warranty Information .....	36

“RUGER,” “GP100” and the Sturm, Ruger logo are registered U.S. trademarks.



## WARNINGS OF GREAT IMPORTANCE ARE FOUND ON THE FOLLOWING PAGES:

Locking Devices	8	Firing	15
Alterations	10	Disassembly	17
Ammunition	11	Lubrication	20
Lead Exposure	12	Storage	21
Handling	12	Shipping	24
Cylinder Interlock	13	Parts Purchasers	25

**OTHER CAUTIONS AND WARNINGS APPEAR THROUGHOUT THE MANUAL.**

# NOMENCLATURE

Figure 1

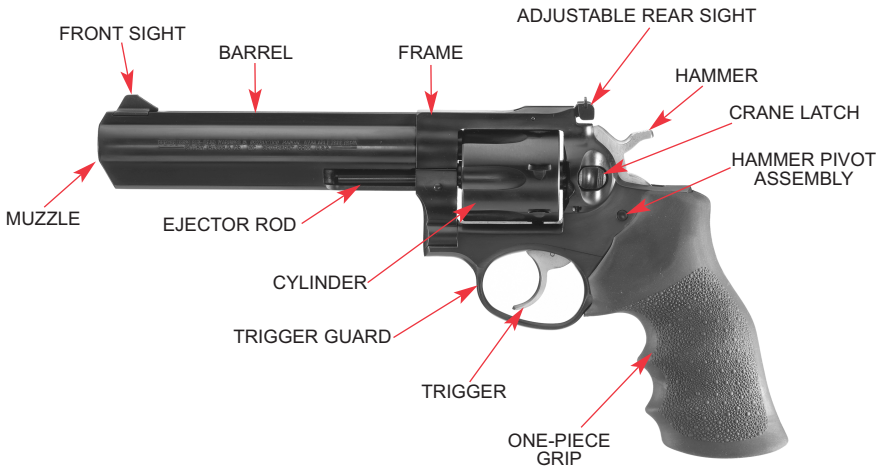
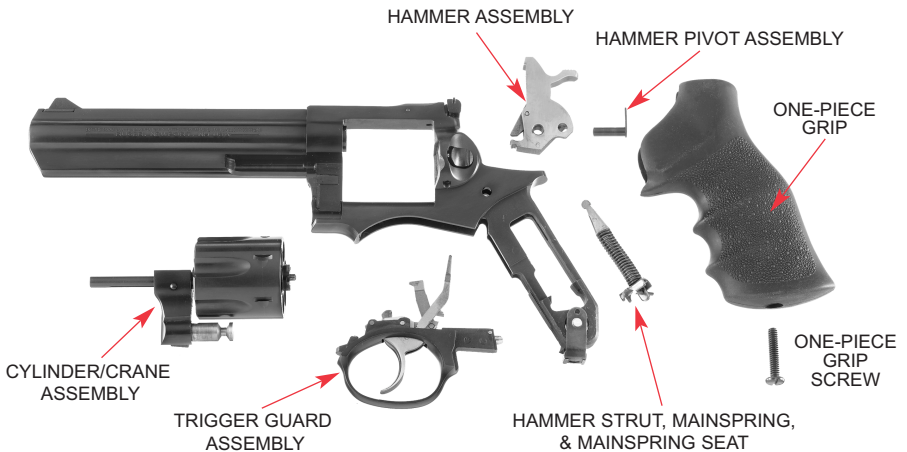

Figure 2



# LOCKING DEVICE INSTALLATION INSTRUCTIONS



## WARNING – USE OF LOCKING DEVICES



**Do not store keys  
in lock.**

- Always keep your firearm pointed in a safe direction, including when you are installing or removing your locking device.
- Always verify that your firearm is completely **unloaded** before installing your locking device.
- Do **not** install locking devices in the trigger guard; always keep your fingers and locking device outside the trigger guard during device installation and removal.
- Store firearms, ammunition and keys separately and securely, away from children and careless adults; do **not** store your firearm with the keys in the locking device.
- Do not attempt to work the action of your firearm with the locking device in place; this may damage your firearm.
- While locking devices are an important aid to security measures, they are not a substitute for safe firearm handling and proper storage. Remember that any mechanical device can be bypassed with enough time, knowledge, determination and equipment.

**LOCKING DEVICES MUST BE USED  
SAFELY AND RESPONSIBLY**

It is important to use the locking device on your Ruger® firearm!

Keep the muzzle pointed in a safe direction and your fingers outside the trigger guard at all times!

### To Install the Factory-Supplied Locking Device:

1. Be sure the firearm is completely unloaded and contains no cartridges or cartridge cases!
2. Completely swing out the cylinder.



3. Insert the cable through the cylinder as shown in Figure 3.
4. To lock: With the key turned to the farthest clockwise position, insert the loose end of the cable into the lock. Turn the key counterclockwise and remove the key.
5. Once the lock is securely closed, pull firmly on the lock to test the connection and be sure it is locked. **Do not leave or store your firearm with the key in the lock!** Store your locked, unloaded firearm and the key in secure, separate locations, away from ammunition, children, and unauthorized adults.



Figure 3

*Correct Installation of Lock  
For Ruger GP100® Revolvers Only*

## FIREARMS ARE DANGEROUS WEAPONS

READ THE INSTRUCTIONS AND WARNINGS IN THIS MANUAL THOROUGHLY AND CAREFULLY BEFORE USING.

	
<b>WARNING-ALTERATIONS</b>	
	This product was designed to function properly in its original condition. Alterations can make it unsafe. Do not alter any part or add or substitute parts or accessories not made by Sturm, Ruger & Co., Inc.
	<b>DO NOT ALTER ANY GUN</b>

## GENERAL INFORMATION AND MECHANICAL CHARACTERISTICS

The RUGER® GP100® revolver is a double action firearm which is specifically designed for heavy Magnum cartridges and embodies many features found in the famous RUGER® REDHAWK® and SECURITY-SIX® revolvers. It is the first of an entirely new generation of Ruger double action revolvers. The unique frame extension permits the use of full wrap-around style grips of any desired configuration. This feature reduces overall weight and contributes to a desirable muzzle of heaviness. The crane and cylinder assembly of the GP100 revolver locks directly into the frame, both at the rear of the cylinder and at the front of the crane. The ejector rod serves only as an ejector – it does not rotate with the cylinder. All of this mechanism is readily removable without tools and dismantles, along with the cylinder/crane group, into a small number of subassemblies for inspection and cleaning (see Figure 2, p. 7).

The internal parts are installed either through the top or bottom of the grip-frame; therefore, *no side plate* is needed. The resulting *double solid frame* contributes greatly to the extraordinary strength and reliability of these revolvers.

The RUGER® GP100® revolver has a transfer bar which is connected directly to the trigger. The transfer-bar safety system provides that the hammer blow can be transmitted to the firing pin only when the trigger is pulled all the way to the rear. This is a positive internal safety feature.

The RUGER® GP100® MATCH CHAMPION™ revolver features a slab-sided, half-lug barrel, and custom Hogue® hardwood grip with stippled sides.

Despite their many highly desirable features, Ruger revolvers—as with all firearms—must at all times be handled with strict attention to correct safety practices, and be inspected frequently to assure the gun is working properly.

# AMMUNITION

RUGER® GP100® revolvers will chamber the 357 Magnum, 38 Special +P, and the 38 Special cartridge. Ruger revolvers are designed for use with cartridges of the correct caliber which are manufactured in accordance with the U.S. Industry Standards. Be certain to use proper cartridges of the correct caliber. See “Care and Cleaning,” p. 20, for important information on chamber cleaning.

**NOTES ON CALIBER 22 LONG RIFLE:** The .22 cal. model is a ten-shot double-action revolver chambered for the .22 Long Rifle cartridge. The 22 Short, 22 Long and 22 shot cartridges can also be fired from this model. It should be noted that extensive use of the 22 Short cartridge can cause a “ring” to be cut in each cylinder chamber which may interfere with the extraction of Long and Long Rifle Cartridges.

**NOTES ON CALIBER 327 FEDERAL MAGNUM (This model is no longer in production):** This seven-shot GP100® chambered for the Caliber 327 Federal Magnum cartridge will also chamber the 32 H&R, 32 S&W and the 32 S&W Long cartridge. The use of other than 327 Federal Magnum cartridges, may, in some loadings, result in unsatisfactory accuracy.

## AMMUNITION (CARTRIDGES) NOTICE

WE SPECIFICALLY DISCLAIM RESPONSIBILITY FOR ANY DAMAGE OR INJURY WHATSOEVER OCCURRING IN CONNECTION WITH, OR AS THE RESULT OF, THE USE IN THE GP100 REVOLVER OF FAULTY, OR NON-STANDARD, OR “RE-MANUFACTURED”, OR HAND LOADED (RELOADED) AMMUNITION, OR OF CARTRIDGES OTHER THAN THOSE FOR WHICH THE FIREARM WAS ORIGINALLY CHAMBERED.

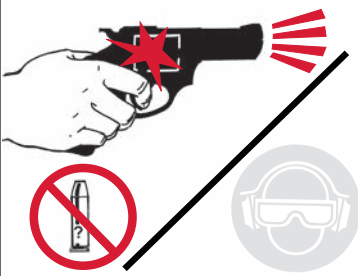
 <b>WARNING – AMMUNITION</b>	
	<p>Death, serious injury, and damage can result from the wrong ammunition, bore obstructions, powder overloads or incorrect cartridge components. <u>Always</u> wear shooting glasses and hearing protection.</p>
<b>IMPROPER AMMUNITION DESTROYS GUNS</b>	



## WARNING – LEAD EXPOSURE



Discharging firearms in poorly ventilated areas, cleaning firearms, or handling ammunition may result in exposure to lead and other substances known to the State of California to cause birth defects, reproductive harm, and other serious physical injury. Have adequate ventilation at all times. Wash hands thoroughly after exposure.

**SHOOTING OR CLEANING GUNS  
MAY EXPOSE YOU TO LEAD**

## HANDLING

**CARRYING:** The GP100 revolver can be carried with all chambers loaded. When the hammer and trigger are fully forward, the transfer-bar is lowered out of its firing position and the hammer rests directly on the frame.



## WARNING – HANDLING



If the trigger is held to the rear, the gun can fire if the hammer strikes the transfer bar. Note that it need not be a deliberate effort to pull the trigger. Any situation where the trigger attains its rearward position and permits the transfer bar to be interposed between the hammer and the firing pin can cause the cartridge under the firing pin to discharge.

**NEVER DROP OR STRIKE THE REVOLVER – COCKED OR UNCOCKED. CARRY AND HANDLE THE REVOLVER IN SUCH A MANNER THAT THE HAMMER AND TRIGGER WILL NOT BE STRUCK.**

**NEVER CARRY ANY REVOLVER WITH THE HAMMER COCKED OR THE TRIGGER HELD TO THE REAR**

## DRY-FIRING

“Dry Firing” is practicing the trigger pull of the empty revolver for practice and familiarity. The GP100 revolver can be dry-fired without damage to the firing pin or internal components.

**Be sure that the revolver is unloaded before handling.** Be sure of your bullet stop, even when dry-firing for practice. Do not dry-fire the revolver with the plastic ‘safety disc’ on the cylinder.

# TO LOAD AND FIRE

**BE SURE THE REVOLVER IS POINTED IN A SAFE DIRECTION AND IS NEVER COCKED WHILE LOADING.**

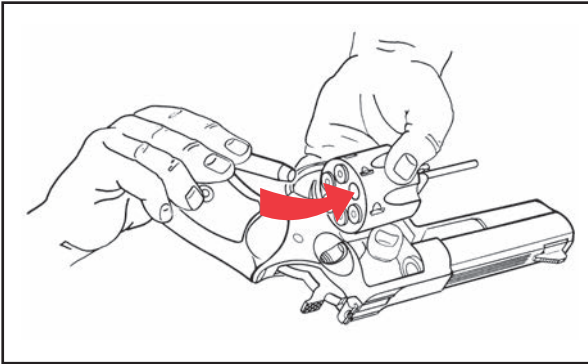

1. Press the crane latch and guide cylinder out of frame to the left to its loading position (See Figure 4).





**Figure 4  
LOADING THE  
REVOLVER.**

2. Insert cartridges and gently close cylinder, making sure it is securely latched. Do not “flip” the cylinder open or shut.



**NOTE:** The revolver has a cylinder latch that locks the rotation of the cylinder before a shot is fired. This cylinder latch rides on the outside circumference of the cylinder where the stop notches are cut in the cylinder. The cylinder latch is designed to leave a line around the outside of the cylinder between the notches. This is normal and is an indication that your revolver is functioning properly.

	
<b>WARNING – CYLINDER INTERLOCK</b>	
	<p>When correctly operated, the cylinder cannot be opened when the hammer is cocked, and the hammer/trigger mechanism is not able to be operated until the cylinder is locked shut. However, this safety interlock can be intentionally defeated if the crane latch is depressed and the hammer is then cocked while the cylinder opened. If the cylinder is then shut when the hammer is cocked, the hammer may fall and the gun may fire.</p>
	<p><b>NEVER CLOSE OR OPEN THE CYLINDER WHILE THE HAMMER IS COCKED</b></p>

3. The revolver is now ready to fire, either “double action” by pulling the trigger through its complete arc for each shot, or “single action” by cocking the hammer and then pulling the trigger for each shot. The trigger pull is somewhat shorter and lighter when the revolver is fired single action, and this is the preferred mode for precise shots or target shooting
4. **DO NOT TOUCH THE TRIGGER UNTIL YOU ARE READY TO FIRE.**

 <b>CAUTION-DOUBLE ACTION FIRING</b>		
<b>1.</b>		<p>When firing in the double action mode, be sure that the trigger is released completely to its fully forward position before pulling the trigger for a subsequent shot. If the trigger finger is allowed to interfere with the full recovery of the trigger (preventing it from moving through about the last one-eighth inch of its forward movement), the trigger cannot be pulled again for another discharge. The trigger must be <b>fully</b> released after each shot is fired. This characteristic is found in all modern double action revolvers and “double action only” pistols.</p>
<b>2.</b>		
<b>FULLY RELEASE TRIGGER BETWEEN SHOTS</b>		

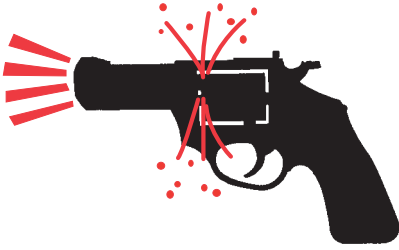
5. **DO NOT HOLD THE REVOLVER BY THE BARREL OR CYLINDER WHEN FIRING.**

 <b>WARNING–FIRING</b>	
	<p>When firing the GP100 revolver, be sure all persons are a safe distance to the rear of the shooter. When fired, all revolvers discharge hot gas and particles of lead, powder grains, or lubricant through the clearance gap between the cylinder and the rear of the barrel at high speed. This can injure a person who is standing too close to the revolver.</p> <p>When firing the GP100 revolver (or any revolver), always be certain that nothing – including your hands – is in the path of the hot gas and particles which are discharged from the front and sides of the cylinder.</p> <p>When shooting, adequate eye protection is essential. Shooters and bystanders must wear shooting glasses. Hearing protection must also be worn. Exposure to shooting noise can damage hearing.</p>
	<b>HOT GASES EXIT BARREL/CYLINDER GAP</b>

## TO UNCOCK (DECOCK) THE REVOLVER

If your revolver is cocked, and you wish to let the hammer down to its forward position (against the frame), proceed as follows: **USE EXTREME CARE WHEN ATTEMPTING TO DECOCK THE REVOLVER, AS THE THUMB SLIPPING DURING THIS PROCESS CAN RESULT IN AN ACCIDENTAL DISCHARGE IF THE TRIGGER IS HELD TO THE REAR.**

1. **Make certain that the revolver is pointed in a safe direction** (see Rule 2, Page 31).
2. Make certain both hands are dry and not impeded in any way – gloves, bandages, cold, etc.
3. Grasp the revolver (if right-handed) so that the thumb and forefinger of your left hand are firmly holding the frame, forward of the trigger guard. Thus, your left hand is in full control of the revolver (See Figure 5A, Page 16).
4. Place your right thumb firmly on the hammer spur and, with your thumb securely in control of the hammer, squeeze the trigger only enough to permit the hammer to ‘break free’ of the trigger. At that instant, **IMMEDIATELY RELEASE THE TRIGGER** and then slowly permit the hammer, **STILL SECURE UNDER YOUR THUMB**, to move fully forward to its resting position against the frame. **NOTE:** It is imperative that finger pressure be removed from the trigger just as soon as it is free of the hammer. Then, properly, the trigger and hammer will move towards their fully forward rest positions together (see Figure 5B, Page 16).

Practice this important gun handling skill with an unloaded revolver until you have developed the proper control and 'touch' to decock your revolver safely. The key to safe decocking is having the weight of the revolver controlled with one hand, while the thumb and forefinger of the 'shooting hand' control the hammer and trigger. Improperly restraining the trigger during this procedure may result in the hammer not resting fully against the frame. If this should occur, carefully repeat the procedure for decocking, steps 1–4 again.

## UNCOCKING THE REVOLVER

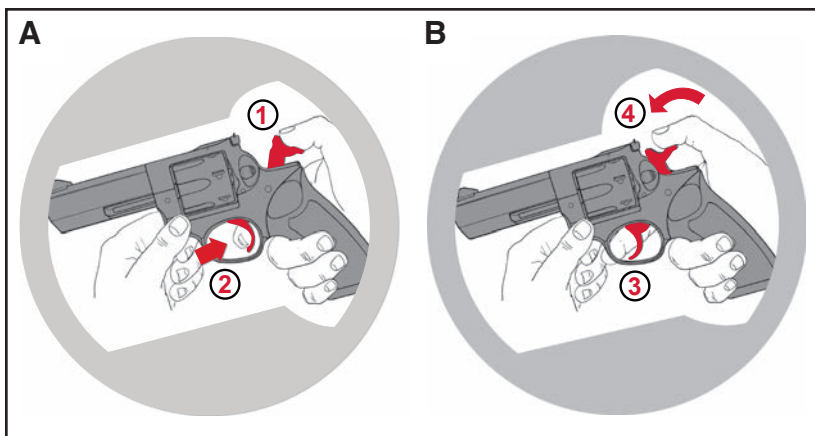

Figure 5

A. With the thumb controlling the hammer as shown (1), squeeze trigger to permit hammer to 'break free' (2).

B. When hammer is free, IMMEDIATELY release trigger (3). Then lower hammer slowly to its resting position completely down against frame (4).

## TO UNLOAD OR EJECT CARTRIDGE CASES

**KEEP THE REVOLVER POINTED IN A SAFE DIRECTION!  
DO NOT ATTEMPT TO UNLOAD WHEN THE HAMMER IS COCKED.**

1. Uncock the revolver (see pp. 15 - 16).
2. Press crane latch. Guide cylinder out left of frame as for loading. The revolver now cannot be fired.
3. Push head of ejector rod smartly toward rear of cylinder until it stops. This action will extract cartridges or fired cases. Do not eject live cartridges onto any surface where a primer might strike a solid object and discharge the cartridge.
4. **Check to be sure all chambers are empty.**



NOTE: When ejecting fired cartridge cases, position the revolver at a high angle so the cases will come fully out of the chambers and not slip under the ejector. This high angle positioning is not necessary when ejecting unfired cartridges.

## CORRECT UNLOADING SEQUENCE

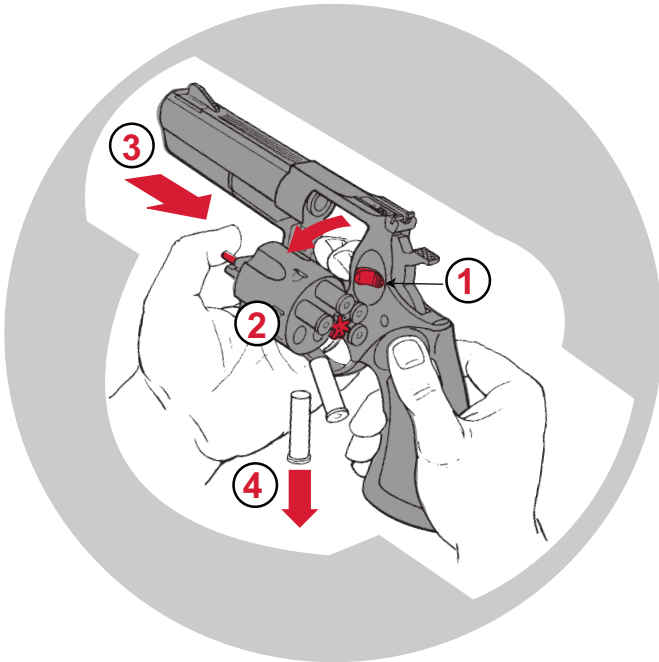

## WARNING – DISASSEMBLY

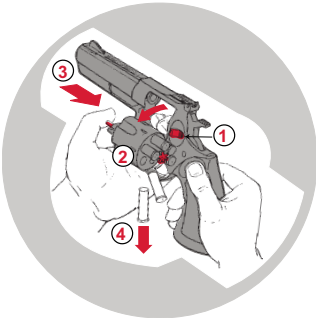

Always unload a firearm before cleaning, lubrication, disassembly or assembly.

Never remove or install a loaded cylinder – it can fire if dropped or struck.

**UNLOAD BEFORE CLEANING**

# DISASSEMBLY

## READ INSTRUCTIONS BEFORE DISASSEMBLING A GUN.

An on-line video demonstrating the disassembly and reassembly of the double-action revolvers can be viewed by going to [Ruger.com/TechTips](http://Ruger.com/TechTips).

### 1. BE CERTAIN THE REVOLVER IS UNLOADED BEFORE DISASSEMBLY.

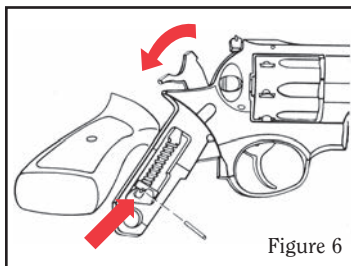

2. Using a properly fitting screwdriver, remove grip screw. Remove pistol grip inserts from grips. Grip panel locator may then be removed. Pull grip downward off frame. Take care not to lose the disassembly pin, which may fall free when the grip is removed.

3. Cock the hammer. Insert disassembly pin about one half its length into the hole at the rear of the mainspring strut (see Figure 6).

Lacking a disassembly pin, any similar instrument will serve.

4. With thumb on hammer spur, squeeze trigger allowing hammer to go fully forward. Lift out mainspring assembly. CAUTION: Do not remove the disassembly pin until the mainspring assembly is reinstalled in the revolver at the time of reassembly. Doing so will permit the mainspring to fly off its strut with great force and may cause injury.

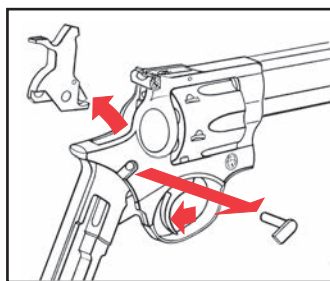

5. Pull trigger and remove hammer pivot while holding trigger in a rearward position. Lift hammer out of the top of the frame while trigger is held in a rearward position (see Figure 7).

Figure 7

6. Use mainspring assembly to depress trigger guard lock plunger located inside frame at rear of trigger guard. Simultaneously pull down and remove trigger guard assembly (see Figures 8 & 9).

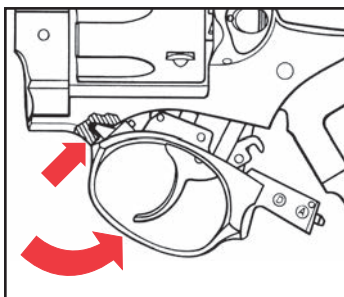

Figure 8

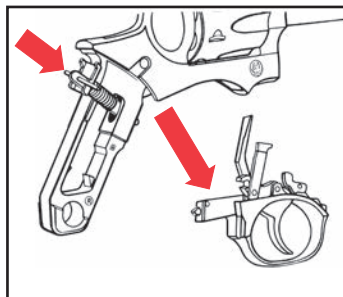

Figure 9

*NOTE: If you cannot supply sufficient force to the plunger using the mainspring assembly as a “tool,” then use a screwdriver of appropriate size and insert through hole in frame. It may be necessary to slightly depress the trigger while removing the trigger guard assembly.*

8. Cradle the revolver frame in your left hand and with the thumb of your right hand press cylinder latch button, swing out cylinder assembly and remove it forward from the frame.
9. Further disassembly is not essential for normal cleaning purposes. Any further disassembly should only be undertaken by factory service personnel.

## REASSEMBLY

### AGAIN, BE CERTAIN REVOLVER IS UNLOADED!

Before starting reassembly, be certain that all components and the inside of the frame are thoroughly clean. In particular the tongue on the front of the trigger guard and its mating recess in the frame must be completely clean.

1. Replace cylinder and crane assembly in frame and close cylinder.
2. Hook front of trigger guard into recess in frame (see Figure 8, p. 18). Align pawl in its recess in the frame and be sure transfer bar is in correct position in rear of firing pin. Swing trigger guard upward into position in frame then allow latch to re-engage. If solid resistance is felt when swinging trigger guard into frame, or if trigger guard will not lock into position, re-check position of pawl and transfer bar (see Figure 10).

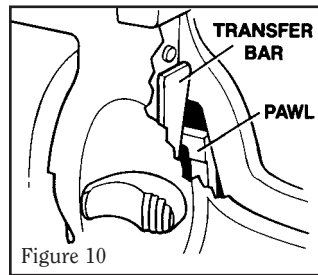

Figure 10

*NOTE: At this point in reassembly trigger should function to rotate and lock the cylinder. Pull the trigger a few times, to check proper functioning, as always with the revolver pointed in a safe direction.*

3. Hold trigger in its rearward position and insert hammer into frame. Install hammer pivot. Release trigger and permit hammer to go fully forward.
4. With hammer forward, insert mainspring assembly into frame. Position the two ends of notch in the mainspring seat onto the matching projections of the grip frame. (Note: The large notch in the mainspring seat should be forward to allow clearance for the grip screw.) Hold mainspring assembly in position and cock hammer. It may be necessary to move the mainspring assembly a little to properly position the upper end of the mainspring strut to rest in recess in the hammer. When the hammer is cocked, disassembly pin can be removed (it will fall free).
5. Squeeze trigger and ease hammer down. Put the disassembly pin in its “nest.” Push grip upward onto the frame, install grip panel locator and place pistol inserts into position. Install and tighten grip panel screw.
6. Open and close cylinder. Function the trigger and hammer single action and double action to be certain that all parts are working properly.



# CARE AND CLEANING

**ALWAYS BE CERTAIN THE REVOLVER IS UNLOADED  
BEFORE CLEANING.**

An on-line video demonstrating the proper cleaning procedure of the double-action revolvers can be viewed by going to **Ruger.com/TechTips**.

The internal mechanism of the GP100® revolver can be lubricated without disassembly. A few drops of light oil recommended as suitable for firearms, applied periodically about the various frame openings, will work its way into the mechanism parts. The exterior of the revolver and the bore and chambers should be thoroughly cleaned and then wiped with an oily cloth if the gun is to be stored. Do not apply excess lubrication.

To clean the revolver after firing, swing the cylinder out and clean the barrel from the muzzle by running a cleaning rod with a solvent coated patch through the bore several times. A bronze wire brush (of correct size for gun caliber) attached to the cleaning rod should then be pushed the full length of the bore several times. Again swab the bore with a solvent coated patch. Then wipe the rod clean and, using a dry patch, swab the bore until it is clean. Examine the bore to be sure that no fouling remains. Repeat the above procedure for each of the six chambers.

 <b>WARNING – LUBRICATION</b>	
	<p>Firing a revolver with oil, grease, or any other material even partially obstructing the bore may result in damage to the revolver and serious injury to the shooter and those nearby.</p> <p>Do not spray or apply lubricants directly on ammunition. If the powder charge of a cartridge is affected by the lubricant, it may not be ignited, but the energy from the primer may be sufficient to push the bullet into the bore where it may become lodged. Firing a subsequent bullet into the obstructed bore may damage the revolver and cause serious injury or death to the shooter and those nearby. Use lubricants properly. You are responsible for the proper care and maintenance of your firearms.</p>
<b>IMPROPER LUBRICATION DESTROYS GUNS</b>	

Chambers must be thoroughly scrubbed to remove build-up of bullet metal and firing residue. A dirty chamber can prevent full seating of a cartridge, which in turn causes the cylinder to bind. **DO NOT APPLY EXCESSIVE OIL TO UNDERSIDE OF EJECTOR – AREA SHOULD BE WIPED DRY WITH OILY CLOTH.** Also, the underside of the ejector ('star') and the area of the cylinder where the ejector seats, must be cleaned. Dirt and combustion by-products can prevent the ejector from fully seating. That condition can cause hard closing of the cylinder and interfere with proper cylinder rotation.

If lead bullet loads are fired extensively, lead build-up may cause cylinder binding. Lubricate the cylinder crane gap with Break-Free® CLP or some other lubrication which meets mil. spec. Mil-1-63460 to prevent this condition.



## STORAGE

**GUNS SHOULD NOT BE STORED LOADED!**

**USE THE LOCKING DEVICE SUPPLIED WITH THE REVOLVER TO RENDER IT INOPERATIVE FOR SAFE STORAGE.**

**(SEE PAGE 8)**

*Do not* keep the revolver in a leather, fabric or canvas holster when it is stored. These materials attract moisture, even though the holster may appear to be perfectly dry.

 <b>WARNING – STORAGE</b>	
	<ul style="list-style-type: none"><li>• <b>Never place or store any firearm in such a manner that it may be dislodged. Firearms should always be stored securely and unloaded, away from children and careless adults.</b></li><li>• <b>Use the locking device supplied with the revolver for storage. The use of a locking device or safety lock is only one aspect of responsible firearms storage.</b></li><li>• <b>For increased safety, firearms should be stored unloaded in a location that is both separate from their ammunition and inaccessible to children and any other unauthorized person.</b></li></ul>
<b>STORE SECURELY &amp; UNLOADED</b>	

# CARE OF STAINLESS STEEL REVOLVERS

Revolvers made of stainless steel are more resistant to corrosion than blued steel revolvers. However, in the interest of proper operation and long life of your revolver, inspect it frequently and clean, lubricate and apply an appropriate rust preventative.

Sometimes surface discoloration may be noted, particularly in the grip area of stainless steel revolvers, resulting from perspiration. Contact with some types of holsters can also cause stains or rusting. Rusting may also occur as a result of the revolver being exposed to moisture, humidity, salt air or chemicals.

Minor discoloration can usually be removed by rubbing the stained area with an abrasive ink eraser, crocus cloth, or a “metal polishing” compound. When using any of these abrasives, proceed with care and use light pressure to achieve a blending of ‘color’ with those areas that are not discolored.

External surfaces of the barrel, frame and cylinder should be cleaned and wiped dry after use or after exposure to adverse conditions. If the revolver is to be stored, coat it with a light film of oil or preservative. Where the revolver is in continuing use, and the presence of oil or grease would be objectionable, then the external surfaces can be coated (after cleaning and drying) with a paste wax formulated for use on metals. Apply the wax sparingly, allow time for it to dry hard, then buff lightly with a soft cloth. When applying the wax, take care that it does not get into the mechanism or on the functioning parts such as the hammer, trigger, crane latch, etc. A properly applied hard wax coating will not interfere with gun handling, and it will provide a measure of protection.

## REAR SIGHT ADJUSTMENT

### RUGER® GP100® MATCH CHAMPION™

**WARNING: ALWAYS ENSURE YOUR FIREARM IS UNLOADED BEFORE ADJUSTING YOUR SIGHTS. AT ALL TIMES YOU SHOULD FOLLOW THE BASIC RULES OF SAFE GUN HANDLING.**

The RUGER® GP100® MATCH CHAMPION™ revolver is equipped with a rear sight which is adjustable for windage only.

To adjust where the group prints, loosen the setscrew in the rear sight using a properly sized Allen Wrench. Move the rear sight in the direction you wish the group to move on the target. For example, if the group should move to the right, move the rear sight to the right. Once the sight is moved to the desired position, tighten the setscrew.

# SIGHTS

The GP100® revolver is provided with an insert front sight. To change the front sight, depress the spring-loaded plunger in the front of the barrel rib with a small punch and lift rear of sight blade. The adjustable rear sight has a white outline blade. Each click of the rear sight adjustment screws (either windage or elevation) will move the point of impact of the bullet approximately 3/4" at a distance of 25 yards. Move the rear sight in the direction you desire the bullet to move on the target.

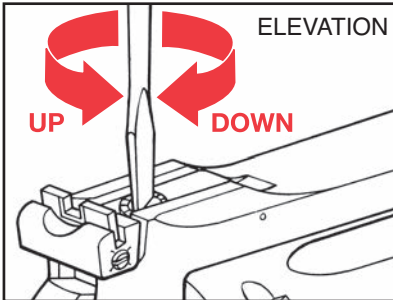

To raise point of impact: turn screw counterclockwise.

To lower point of impact: turn screw clockwise.

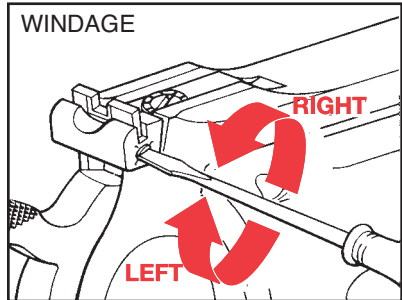

To move the point of impact to the right: turn screw counterclockwise.

To move the point of impact to the left: turn screw clockwise.

## SUGGESTED SIGHT PICTURE

Top of front sight even with top of rear sight blade.

Front sight centered in notch of rear sight blade. Target bull's-eye centered on top of front sight.

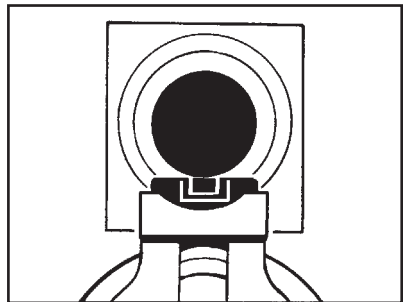

## SIGHT ADJUSTMENTS 327 FEDERAL MAGNUM

(THIS MODEL IS NO LONGER IN PRODUCTION)

The GP100® 327 Fed. Mag. revolvers are equipped with sights adjustable for windage. Each click of the rear sight adjustment screw will move the point of bullet impact approximately 1/2" on the target at 25 yards using a 4" barrel length.

To move the point of impact to the right: Turn the click screw counterclockwise.

To move the point of impact to the left: Turn the click screw clockwise.

## SERVICE AND PARTS POLICY

If you have any questions with regard to the performance of your RUGER® GP100® revolver, please write or call (336-949-5200) our Newport, New Hampshire Customer Service Department, fully describing all circumstances and conditions involved. If you should return your revolver to the factory for repair, or order parts for it, please comply with the following suggestions for prompt service:



**WARNING: BEFORE SHIPPING ANY FIREARM, BE ABSOLUTELY CERTAIN THAT IT IS UNLOADED. DO NOT SHIP CARTRIDGES WITH A FIREARM.**

### SHIPPING FIREARMS FOR REPAIR

RUGER® GP100® revolvers returned for repairs should be sent to : Sturm, Ruger & Company, Inc., Customer Service Department, 411 Sunapee Street, Newport, New Hampshire 03773. **NOTE:** You must obtain a Repair Authorization Number before returning your firearm. An authorization number can be obtained by contacting Customer Service online at [www.ruger.com](http://www.ruger.com) or calling the Customer Service Dept. at 336-949-5200. Guns should be sent prepaid. We will not accept collect shipments.

The Federal Gun Control Act, as well as the laws of most states and localities, do not prohibit an individual (who is not otherwise barred from purchasing or possessing a firearm) from shipping a firearm directly to the manufacturer for repair. However, before shipping your revolver to us, be certain your state or locality does not have a law or regulation which will prohibit you from receiving your revolver from us after it has been repaired. If such receiving is prohibited, then please have a federally licensed firearms dealer ship the gun to us. If your gun is sent to us by a dealer, it will be returned to that dealer after being repaired. If a handgun is shipped by an individual who does not hold a Federal Firearms License, it must be shipped for overnight delivery via U.P.S., Federal Express, or other similar private overnight service. NOTE: Handguns may not be shipped via U.S. Mail. Persons who do not hold a Federal Firearms License are prohibited by Federal law from shipping a handgun by mail. Handguns mailed in violation of the law are impounded by the Post Office. **DO NOT SEND GUN BOXES OR LITERATURE THAT YOU CONSIDER TO BE COLLECTOR'S ITEMS – THESE ARE INVARIABLY DAMAGED OR DESTROYED IN SHIPMENT.** Please do not include holster, grip panels, or other accessories with a firearm being shipped to the factory for service. Always insure your shipment.

Enclose a letter which includes your name, address, telephone number, serial number, model of the firearm, and your repair authorization number. Describe the trouble you have experienced with your revolver, or the work you wish to have done. Merely saying that the revolver “needs repair” is inadequate information. State precisely what is wrong. Please enclose copies of any previous correspondence.

All work performed is subject to a minimum labor charge and charges for shipping and handling. Most models can be reblued, but custom gunsmithing service or nonstandard alterations are NOT AVAILABLE from Ruger Customer Service Departments. Please contact the Customer Service Department for pricing information.





## WARNING – PARTS PURCHASERS



- It is the purchaser's responsibility to be absolutely certain that any parts ordered from the factory are correctly fitted and installed.
- Firearms are complicated mechanisms and **IMPROPER FITTING OF PARTS MAY RESULT IN A DANGEROUS MALFUNCTION, DAMAGE TO THE FIREARM, AND SERIOUS INJURY TO THE SHOOTER AND OTHER PERSONS.**
- The purchaser and installer of parts must accept full responsibility for the correct adjustment and functioning of the firearm after such installation.

**PARTS MUST FIT CORRECTLY**

## ORDERING PARTS

Please contact the New Hampshire Customer Service Department for parts availability and current prices. All parts orders for the RUGER® GP100® revolvers should be sent to : Sturm, Ruger & Co., Inc., Customer Service Department, 411 Sunapee Street, Newport, New Hampshire, 03773, 336-949-5200. We cannot comply with open account or C.O.D. orders. Payment in full via credit card (Visa or MasterCard only), money order or certified bank check (no personal checks or cash, please) is required before any service will be performed. Please provide your credit card number, your name as it appears on the credit card, the expiration date, and the 3-digit security code. All parts orders are subject to a minimum charge and charges for shipping and handling. Order parts by **Part Name and specify the model and entire serial number** of the firearm for which the parts are being ordered. There is a minimum labor charge plus a shipping and handling charge if the parts are factory fitted. All factory fitted parts are fit on an exchange basis only. We will not return the replaced parts. Please contact the Customer Service Department for pricing information.

Barrels, cylinders, cylinder/crane assemblies and a number of other component parts must be fitted at the factory. Company policy is to proof-test and/or function fire all barrels after fitting to the receivers in which they are to be used. This procedure ensures maximum protection to our customers. The special proof-test ammunition used in this testing is sold only to bonafide firearms manufacturers and is not available to gun shops, gunsmiths or individuals.

Because it is a serial numbered part, the frame of the RUGER® GP100® revolver is defined as a 'firearm' by Federal Law and is not offered for sale as a component part.

Parts designated by an asterisk (\*) must be factory fitted. These parts are fitted on an exchange basis only. We will not return the replaced parts. We will not return any part that is broken, malfunctioning, badly worn or has been modified. See "Warning – Parts Purchasers" above.



**WARNING: A gun containing broken, malfunctioning or badly worn parts should not be fired.**

# RUGER® GP100®

## PARTS LIST

Design, prices and specifications subject to change without notice.

**SPECIFY MODEL, CALIBER AND SERIAL NO. WHEN ORDERING**

(See Exploded View on Page 28.)

Key No.	Part Name
* 1	Barrel
† 2	Cylinder Frame
3	Firing Pin Spring
* 4	Crane Pivot Lock Plunger
* 5	Trigger Guard
* 6	Crane Pivot Lock Spring
* 7	Cylinder Latch Pivot
* 8	Firing Pin Plug
9	Trigger Guard Latch
10	Hammer Dog Pivot Pin
* 11	Firing Pin
12	Trigger Guard Latch Spring
* 13	Cylinder Retaining Ball, 2 Req'd
* 14	Crane
* 15	Cylinder
* 16	Ejector
17	Pawl Plunger
* 18	Hammer
19	Hammer Dog
20	Hammer Dog, Crane Latch, & Front Latch Springs
* 21	Trigger
22	Trigger Link
23	Trigger Cross Pin
24	Hammer Pivot Pin Assembly
25	Ejector Rod
* 26	Pawl
27	Front Latch Pivot Lock
28	Front Latch Spring Plunger
29	Front Latch Pivot Pin
30	Front Latch
* 31	Ejector Retainer
32	Transfer Bar
33	Hammer Strut
34	Hammer Strut Mainspring
35	Mainspring Seat
36	Pawl Spring Plunger

\* PARTS SO MARKED MUST BE FACTORY FIT

† Because it is a serial numbered part, the cylinder frame is defined as a 'firearm' by Federal Law and is not offered for sale as a component part.

Key No.	Part Name
* 37	Crane Latch
38	Front Latch Pivot Lock Spring
39	Center Pin Rod
40	Pawl Plunger Spring
41	Cylinder Latch
42	Trigger Plunger
43	Trigger Pivot Pin
44	Center Pin
45	Center Pin Spring
* 46	Crane Latch Pivot
47	Ejector Spring
48	Trigger Link Plunger
49	Rear Sight Base
50	Rear Sight Blade
51	Rear Sight Elevation Screw
52	Pawl Plunger Spring
53	Rear Sight Windage Adjustment Screw
54	Rear Sight Elevation Spring, 2 Req'd
55	Rear Sight Pivot Pin
56	Front Sight Plunger
57	Front Sight Spring
58	Front Sight
59	Grip

\* PARTS SO MARKED MUST BE FACTORY FIT

GP100®  
EXPLODED VIEW

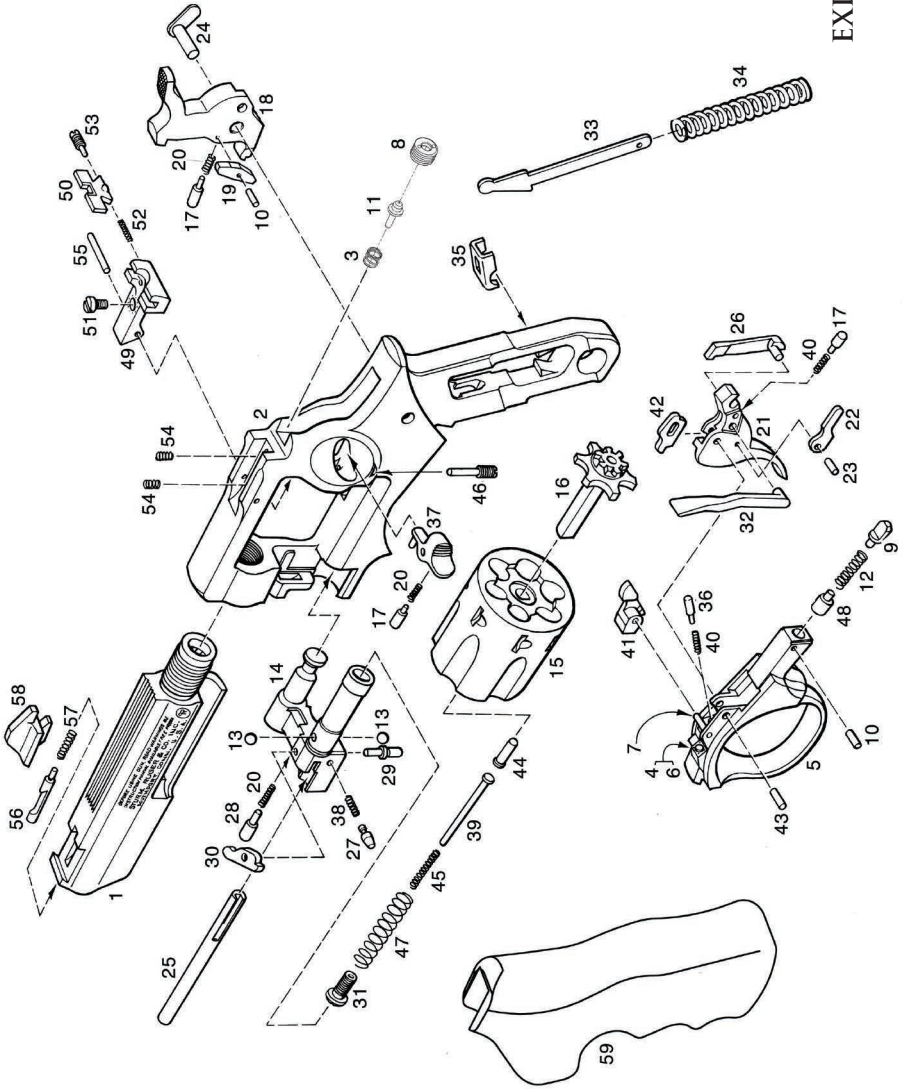

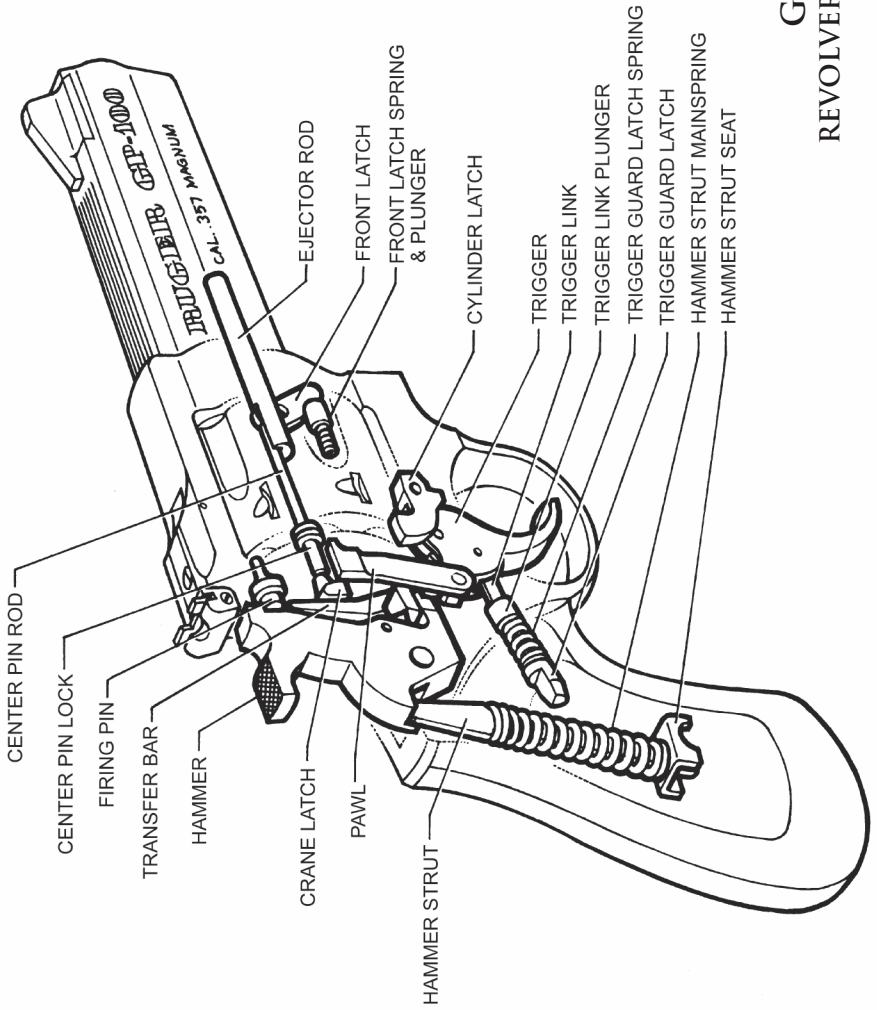

GP100®  
REVOLVER MECHANISM

# RUGER® GP100® MATCH CHAMPION™

## SUPPLEMENTAL PARTS LIST AND EXPLODED VIEW

Key No.	Part Name
* 1	Barrel
† 2	Cylinder Frame
* 5	Trigger Guard
* 15	Cylinder
* 16	Ejector
* 18	Hammer
* 21	Trigger
49	Rear Sight, Novak
58	Front Sight, Novak
59	Hogue Wood Grip
60	Hammer Shims, 2 Req'd
61	Grip Panel Locator

\* PARTS SO MARKED MUST BE FACTORY FIT

† Because it is a serial numbered part, the cylinder frame is defined as a 'firearm' by Federal Law and is not offered for sale as a component part.

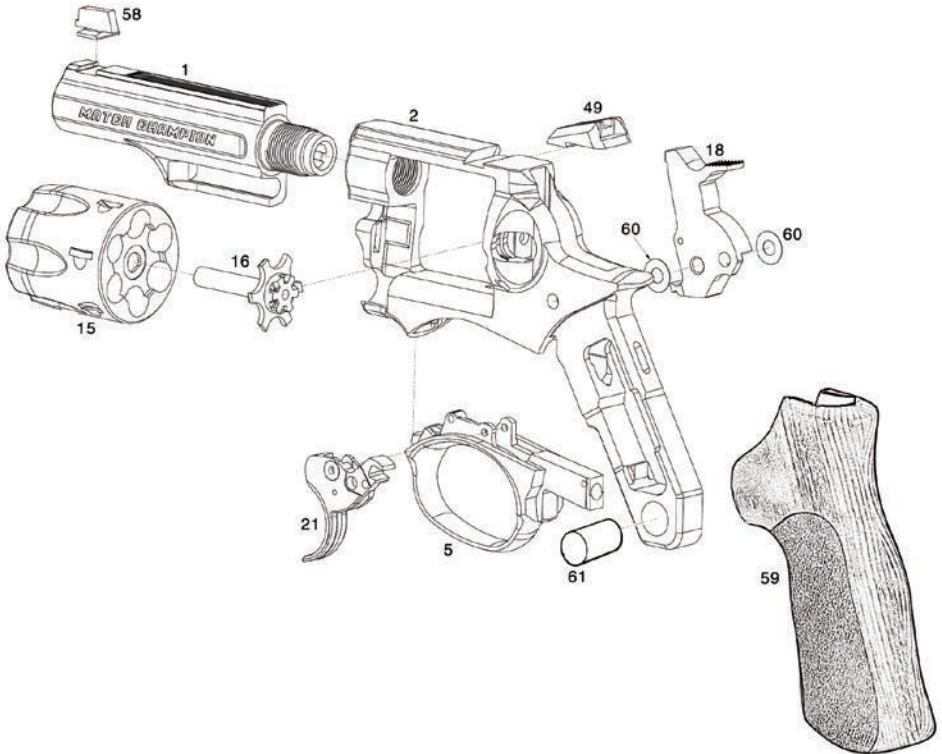

# THE BASIC RULES OF SAFE FIREARMS HANDLING

We believe that Americans have a right to purchase and use firearms for lawful purposes. The private ownership of firearms in America is traditional, but that ownership imposes the responsibility on the gun owner to use his firearms in a way which will ensure his own safety and that of others. When firearms are used in a safe and responsible manner, they are a great source of pleasure and satisfaction, and represent a fundamental part of our personal liberty.

Firearms do not cause accidents! Firearms accidents are almost always found to have been the result of carelessness or ignorance on the part of the shooter of the basic rules of safe gun handling.

The following rules must be observed by gun users at all times. Safe gun handling is not just desirable, it is absolutely essential to your safety, the safety of others, and the continuation of gun ownership and sport shooting as we know it today.

## 1. LEARN THE MECHANICAL AND HANDLING CHARACTERISTICS OF THE FIREARM YOU ARE USING.

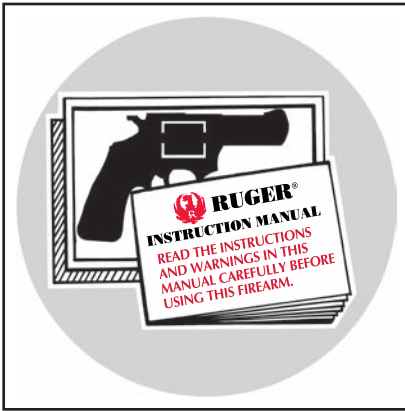

Not all firearms are the same. The method of carrying and handling firearms varies in accordance with the mechanical provisions for avoiding accidental discharge and the various proper procedures for loading and unloading. No person should handle any firearm without first having thoroughly familiarized himself with the particular type of firearm he is using, and with safe gun handling in general.

## 2. ALWAYS KEEP THE MUZZLE POINTED IN A SAFE DIRECTION.



Be sure of the bullet stop behind your target, even when dry-firing. Never let the muzzle of a firearm point at any part of your body or at another person. This is particularly important when loading or unloading a firearm. In the event of an accidental discharge, no injury can occur as long as the muzzle is pointing in a safe direction. A safe direction means a direction that will not permit a discharged bullet to strike a person, or to strike an object from which the bullet may ricochet.

A safe direction must take into account the fact that a bullet may penetrate a wall, ceiling, floor, window, etc., and strike a person or damage property. Make it a habit to know exactly where the muzzle of your gun is pointing whenever you handle it, and be sure that you are always in control of the direction in which the muzzle is pointing, even if you fall or stumble. Keep your finger off the trigger until you are ready to shoot!

### 3. FIREARMS SHOULD BE UNLOADED WHEN NOT IN USE.

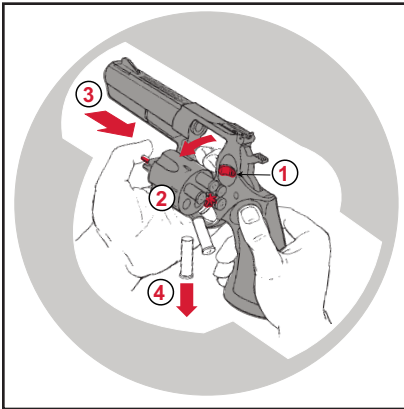

Firearms should be loaded only when you are in the field or on the target range or shooting area, ready to shoot. Firearms and ammunition should be securely locked in safes, racks or cabinets, or by using the locking device supplied with the firearm, when not in use. Ammunition should be safely stored separate from firearms. Store your firearms out of sight of visitors and children. It is the gun owner's responsibility to be certain that children and

persons unfamiliar with firearms cannot gain access to firearms, ammunition, or components.

### 4. BE SURE THE BARREL IS CLEAR OF OBSTRUCTIONS BEFORE SHOOTING.

Even a bit of mud, snow or excess lubricating oil or grease in the bore may cause the barrel to bulge, or even burst on firing, and can cause serious injury to the shooter and bystanders. Be sure that you are using ammunition of the proper caliber and loading for the gun you are using. If the report or recoil on firing seems weak, or doesn't seem quite right, **CEASE FIRING IMMEDIATELY**, unload your firearm, and check to be sure that no obstruction has become lodged in the barrel.







## 5. BE SURE OF YOUR TARGET BEFORE YOU SHOOT.

Don't shoot unless you know exactly where your bullet is going to strike. Be sure of the bullet stop behind your target, even when dry-firing with an unloaded gun. If you are in the field hunting, do not fire at a movement or noise. Take the time to be absolutely certain of your target before you pull the trigger.

## 6. WEAR SHOOTING GLASSES AND HEARING PROTECTION WHEN YOU SHOOT.

All shooters should wear protective shooting glasses and adequate hearing protection when shooting. Exposure to shooting noise can damage hearing, and wearing adequate eye protection when shooting is essential.



## 7. NEVER CLIMB A TREE OR FENCE WITH A LOADED FIREARM.

Put the firearm down carefully before climbing a fence, and unload it before climbing or descending a tree or jumping over a ditch or other obstruction. Never pull or push a loaded firearm toward yourself or another person. When in doubt, or whenever you are about to do anything awkward, unload your gun!

## 8. DON'T SHOOT AT A HARD SURFACE OR AT WATER.

Bullets can glance off many surfaces like rocks or the surface of water and travel in unpredictable directions with considerable velocity.



## 9. NEVER TRANSPORT A LOADED FIREARM.

Firearms should always be unloaded before being placed in a vehicle. A suitable carrying case or scabbard should be used to carry an unloaded firearm to and from the shooting area.

## 10. AVOID ALCOHOLIC BEVERAGES WHEN SHOOTING.

Don't drink until the day's shooting is over. Handling firearms while under the influence of alcohol in any form, or medications that could affect your judgment or coordination, constitutes a criminal disregard for the safety of others.



## A BRIEF ACCOUNT OF AN EXTRAORDINARY ACHIEVEMENT: RUGER® FIREARMS

Sturm, Ruger & Company, Inc., had its beginning in a small machine shop occupying a rented frame building in Southport, Connecticut. In January, 1949, with an initial investment of only \$50,000 and an idea, William B. Ruger and Alexander M. Sturm started production of a .22 caliber autoloading pistol—a design which was so successful that it became the cornerstone upon which one of the most comprehensive lines of sporting firearms ever made in America was established. After Alex Sturm's death in 1951, William B. Ruger continued to direct the Company until his death in 2002. William B. Ruger, Jr. continued to provide guidance, which helped make this Company a sound and successful enterprise, until his retirement in 2006. The Company has continued to prosper, under new management and guidance from our Board, with new products and fresh perspectives.

Ruger, in this relatively short time, has established itself as a leading small arms design organization, developing a unique and broad line of fine quality sporting, military and police firearms to become one of the world's most famous producers of revolvers, pistols, rifles and shotguns. Since 1949, Ruger craftsmen have built many millions of firearms.

During its six decades of growth and progress under the leadership of William B. Ruger, the Company developed a business philosophy and implemented policies which represent a constructive influence in the life of modern America. From the beginning, Ruger played a positive role in conservation efforts and has supported the interests of shooters through such groups as the National Rifle Association, National Shooting Sports Foundation, and many regional sportsmen's organizations.

The Company has always endeavored to market its firearms for constructive and recreational purposes, to emphasize the traditional and responsible aspects of shooting, to render meaningful public services, and to encourage shooters in constructive, responsible, and safe participation in the shooting sports. Its motto, "Arms Makers For Responsible Citizens®," exemplifies this Company philosophy.

Today, Ruger® is particularly mindful of those elements which have contributed to the creation of its success, and extends heartfelt thanks to its many loyal employees and customers.

The firearms catalog, and instruction manuals for all Ruger® firearms, can be downloaded from our website at:

**[www.ruger.com](http://www.ruger.com)**

## WHY NO WARRANTY CARD HAS BEEN PACKED WITH THIS NEW RUGER® FIREARM

The Magnuson-Moss Act (Public Law 93-637) does not require any seller or manufacturer of a consumer product to give a written warranty. It does provide that if a written warranty is given, it must be designated as “limited” or as “full” and sets minimum standards for a “full” warranty. Sturm, Ruger & Company, Inc. has elected not to provide any written warranty, either “limited” or “full”, rather than to attempt to comply with the provisions of the Magnuson-Moss Act and the regulations issued thereunder. There are certain implied warranties under state law with respect to sales of consumer goods. As the extent and interpretation of these implied warranties varies from state to state, you should refer to your state statutes. Sturm, Ruger & Company wishes to assure its customers of its continued interest in providing service to owners of Ruger® firearms.



**STURM, RUGER & COMPANY, INC.**  
411 SUNAPEE STREET  
NEWPORT, NEW HAMPSHIRE 03773 U.S.A.  
[WWW.RUGER.COM](http://WWW.RUGER.COM)  
**ARMS MAKERS FOR RESPONSIBLE CITIZENS®**

**A COPY OF THE INSTRUCTION MANUAL FOR ANY RUGER®  
FIREARM IS AVAILABLE FROM THE FACTORY FREE ON REQUEST, OR IT MAY BE  
DOWNLOADED FROM OUR WEBSITE AT [WWW.RUGER.COM](http://WWW.RUGER.COM).  
THESE INSTRUCTION MANUALS CONTAIN IMPORTANT  
WARNINGS WHICH MUST BE UNDERSTOOD  
BEFORE USING THESE FIREARMS.**

**The Following are Sturm, Ruger & Co., Inc. Trademarks:** “BX-Trigger,” “Bisley,” Eagle Hard “R” logo holding gun, Eagle “SR,” “Elite 452,” “Gold Label,” “I’m a Ruger American,” “LC6,” “LCR-357,” “LC380CA,” “Mark II,” “Mark III,” “Match Champion,” “Model 96,” “P345,” “P345D,” “P345PR,” “P85,” “P90,” “P91,” “P93,” “P94,” “P95,” “P97,” “R.I.O.S.,” “Ruger Marksman Adjustable,” “Ruger 77/50,” “Ruger 10/17,” “77/357,” “Single-Seven,” “SR45,” “SR-556C,” “SR-556VT,” “SR-762,” “10/22-FS,” “This is Ruger. This is America.,” “Tri-Flex,” “22 Charger,” “22/45,” and “22/45 RP.”

**The Following are Registered U.S. Trademarks Belonging to Sturm, Ruger & Co., Inc.:** Sturm,Ruger Logo,” “AC-556,” “AR-556,” “Arms Makers For Responsible Citizens,” “All-Weather,” “Bearcat,” “Blackhawk,” “BX-15,” “BX-25,” Eagle ‘R’ - soft ‘R’ & hard ‘R,’ Eagle ‘SR,’ “Everything you need and nothing you don’t.,” “GP100,” Hard “R” Logo, “Hawkeye,” “It’s Mine and It’s American,” “It’s Mine. And It’s American,” “LC380,” “LC9,” “LC9s,” “LC9s Pro,” “LCP,” “LCR,” “LCRx,” “M77,” “Mini Thirty,” “Mini-14,” “9E,” “Old Army,” “Power Bedding,” “Redhawk,” “RUGER,” “Ruger American Pistol,” “Ruger American Rifle,” “Ruger American Rimfire,” “Ruger Hunting” - phrase & logo design, “Ruger Inside & Out” - phrase & logo design, “Ruger Precision Rifle,” “Ruger 77/17,” “Ruger 77/22,” “Ruger 77/44,” “Ruger SP101,” “Ruger 10/22 Takedown” phrase & logo design, “Ruger Titanium,” “Ruger 22/45 Lite,” “Ruger Vaquero,” “Rugged, Reliable Firearms,” “Security-Six,” “Service-Six,” “Silent-SR,” “Single-Nine,” “Single-Six,” “Single-Ten,” “Speed-Six,” the “SR” Design, “SR9,” “SR9c,” “SR40,” “SR40c,” “SR-22,” “SR22,” “SR-556,” “SR-556E,” “SR-556 Takedown,” “SR1911,” “Super Redhawk Alaskan,” “Target Grey,” and “10/22.”

# INSTRUCTION MANUAL INSERT FOR RUGER® GP100® 44 SPECIAL CALIBER



**NOTE:** The RUGER® GP100® revolver chambered for 44 Special has the same basic operational characteristics as all other GP100® revolvers.

## AMMUNITION

RUGER® GP100® revolvers are designed for use with cartridges of the correct caliber which are manufactured in accordance with the U.S. Industry Standards. Be certain to use proper cartridges of the correct caliber. See page 20 of the enclosed instruction manual (“Care and Cleaning”) for important information on chamber cleaning.

This five-shot GP100® is chambered for the .44 Special cartridge *only*.

## RUGER® GP100® REVOLVER ~ 44 SPL SUPPLEMENTAL PARTS LIST

Key	Part Name
1	Front Sight
2	Hogue® Grip
* 3	Ejector
* 4	Cylinder, 5-shot, 44 SPL
* 5	Barrel

\* Parts so marked must be factory fitted.

~ SEE OTHER SIDE FOR EXPLODED VIEW DRAWING ~

RUGER® GP100® REVOLVER ~ 44 SPL  
SUPPLEMENTAL PARTS EXPLODED VIEW

